



Synway CTI Series

SHT-8C/PCI/FAX

Analog Fax Board

Hardware Manual

Version 1.1

Synway Information Engineering Co., Ltd

www.synway.net

Contents

Contents	i
Copyright Declaration	ii
Revision History	iii
Chapter 1 Overview.....	1
1.1 Functions	1
1.2 Features.....	2
1.3 Operation Principle	3
1.4 Functional Modules.....	3
Chapter 2 Installation.....	6
2.1 Hardware Structure	6
2.2 System Requirements.....	9
2.3 Installation Procedure	9
Appendix A Technical Specifications.....	13
Appendix B Technical/sales Support.....	14

Copyright Declaration

All rights reserved; no part of this document may be reproduced or transmitted in any form or by any means, electronic or mechanical, without prior written permission from Synway Information Engineering Co., Ltd (hereinafter referred to as 'Synway').

Synway reserves all rights to modify this document without prior notice. Please contact Synway for the latest version of this document before placing an order.

Synway has made every effort to ensure the accuracy of this document but does not guarantee the absence of errors. Moreover, Synway assumes no responsibility in obtaining permission and authorization of any third party patent, copyright or product involved in relation to the use of this document.

Revision History

Version	Date	Comments
Version 1.0	2007-2	Initial publication
Version 1.1	2011-11	Changes: added a new module EM2V100.

Note: Please visit our website <http://www.synway.net> to obtain the latest version of this document.

Chapter 1 Overview

The CTI Series SHT-8C/PCI/FAX is the 8-channel analog fax board with PCI bus. All functions found on general voice boards and specific station boards are available with this board by configuring the various functional modules in different ways.

1.1 Functions

- A single board can be installed with at most 4 dual-channel modules, supports 8 voice channels
- Supports ring-alert for external calls
- Station phones on-hook/off-hook detection
- Direct connection between trunk and station keeps call uninterrupted during power outage
- Calling party info (Caller ID) detection / transmission, DTMF and FSK support
- Activity/silence detection
- Automatic Gain Control (AGC) support in recording operation
- DTMF transmission and detection
- The fax channel can be shared by all the voice channels, supports the transmit/receive rate of 14400bps
- The flexible distributed conferencing system sets no limit on the number of simultaneous conferences and participants in each conference, allows monitoring and recording of the whole conference and each individual speaker
- Includes audio output interface. The first channel on the board equipped with an analog audio amplifier circuit can directly connect to the headset or sound box, and play voices to a particular channel via a simple function call
- Automatic line voltage detection
- Automatically checks the board to determine the number and type of modules on the board
- Each board has a unique hardware serial number written in the firmware to distinguish itself from other boards and prevent piracy. The number is available via an easy function call with applications
- The on-board authorization code identification circuit is designed for software safety. Users can apply to our company for the authorization code

- The on-board lightning-proof circuit reaches the telecom standard and eliminates the damage caused by the lightning

1.2 Features

- **PCI 2.1 Bus Support**

Includes PCI 2.1 bus with burst data transmission rate up to 132 MB/s; PNP (plug and play) feature eliminates the need for jumper leads.

- **On-board SIMM Slots**

Fit modules to board. Contacts on both sides greatly improve connection and ease installation.

- **Module Configurable**

4 on-board dual-channel modules can be freely arranged in pairs or groups for various complex, multi-functional applications, such as call center and recording functions available on a single board.

- **Available RJ11 Jack**

The available on-board RJ11 jacks can be directly connected to phone lines or converted via a two-way hub, making connection easy and malfunctions rare.

- **External Ringing Current & Battery Feed Power Supply**

Provides station modules with battery feed, and enables the phones which are linked to station channels to ring.

- **Programmable Tone Detector**

Detects single or dual tones at any frequency, offering facility for use with a variety of PBXes and key telephone systems.

- **Professional Driver Algorithm**

Uses SPECDial - a professional driver algorithm - to perform a complete automatic dial process through analog lines, accurately identifies called-party statuses and precisely distinguishes an answering machine from a fax machine that is responding at the remote end.

- **Echo Cancellation**

The self-adaptive echo cancellation feature effectively eliminates echoes under various conditions, which cancels out the effect of voice playback on DTMF and busy tones detection, avoids self-excited oscillation and howling, and minimizes the possibility of registering wrong DTMF and busy tones in a conference call.

- **Various CODECs Support**

Offers a large selection of voice CODECs, including hardware-based A-Law, μ -Law,

IMA-ADPCM, software-based 16-bit linear PCM, MP3 and VOX.

- **Supports WAV File**

The recorded voice files can be edited and played by audio tools such as Cooledit.

- **Synway's Unified SynCTI Driver Development Platform**

Synway owns the intellectual property rights for the unified high-intelligence SynCTI driver development platform. Each system supports up to 2048 channels. Functions such as the detection and analysis of rings, tones and Caller IDs, are available via simple function calls on the driver platform, without having to understand complex call procedures.

1.3 Operation Principle

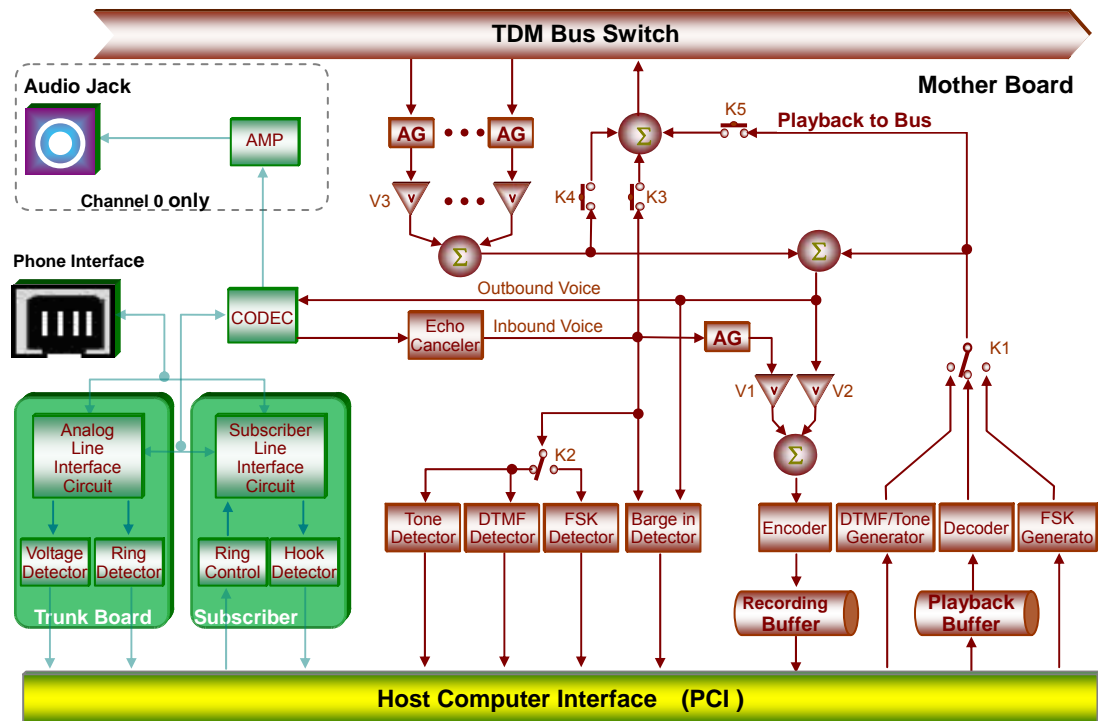

Figure 1-1 Operation Principle

1.4 Functional Modules

This board can be used with the 2.0 series modules from Synway, including analog trunk module, station module, trunk-station composite module, trunk-record composite module and magnet module.

- **Analog Trunk Module**

This module is equipped with the lightning-proof circuit that reaches the telecom standard, and connects its corresponding channel directly to local lines from Central Office Terminal (COT), with abilities to detect line voltage, diagnose line failure, and

judge the on-hook/off-hook state of the station phone which is linked with it. See Figure 2-3 and Figure 2-4 for more information.

- **Station Module**

This module functions either as a station phone provided it links directly to a telephone or as an extension phone for the PBX, supporting delivery of the calling party information in FSK/DTMF to the phone. It uses -40V battery feed voltage and the integrated overcurrent/overvoltage circuit protection system, can accommodate a subscriber line in length of up to 5.5km. Refer to Figure 2-5 and Figure 2-6 for details.

- **Trunk-Station Composite Module**

This module accommodates an analog trunk channel and a station channel, ensuring safe communication via an automatic direct connection of the analog trunk channel and the station channel when the driver is not running or the PC is powered off. See Figure 2-7 and Figure 2-8 for details.

- **Trunk-Record Composite Module**

This module embraces two channels. One is for high-impedance recording in parallel connection and the other works as an analog trunk. See Figure 2-9 and Figure 2-10 for more information.

- **Magnet Module**

This module enables the direct connection of its corresponding channel with a magnet phone line so as to simulate the functions provided by magnet telephones. Refer to Figure 2-11 and Figure 2-12 for details.

- **EM2V100 Module**

A single EM2V100 module can transfer 2-line voice data and meanwhile perform EM control. Two EM2V100 modules can be used either as two EM trunk channels each of which carries 2-line voice data or an EM trunk channel which carries 4-line voice data. To use two EM2V100 modules, set 2 voice lines for incoming calls and another 2 voice lines for outgoing calls, and select one from the two pairs of E&M lines to perform EM control. See Figure 2-13 and Figure 2-14.

See below for the connection of the EM2V100 module.

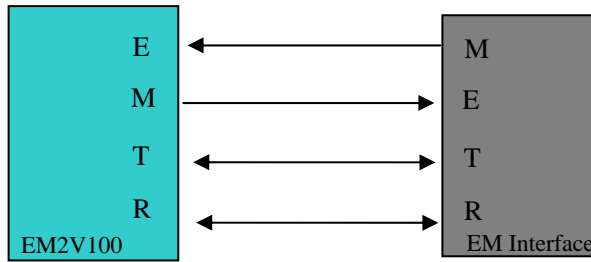

Connect to EM Interface Carrying 2-line Voice Data

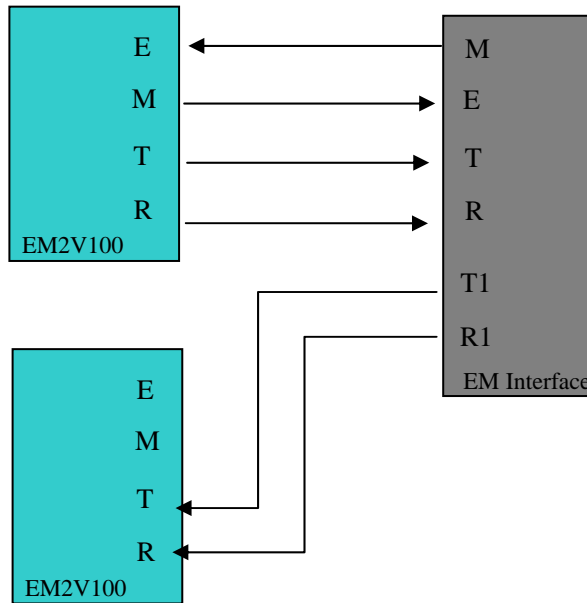

Connect to EM Interface Carrying 4-line Voice Data

See below for the pin definition of a single RJ45.

Pin No.	Pin Definition for EM2V100
1	E0
2	M0
3	Vp0
4	Vn0
5	E1
6	M1
7	Vp1
8	Vn1

See below for the pin definition of a single RJ11.

Pin No.	Pin Definition for EM2V100
1	E0
2	M0
3	Vp0
4	Vn0

Chapter 2 Installation

2.1 Hardware Structure

- SHT-8C/PCI/FAX Board

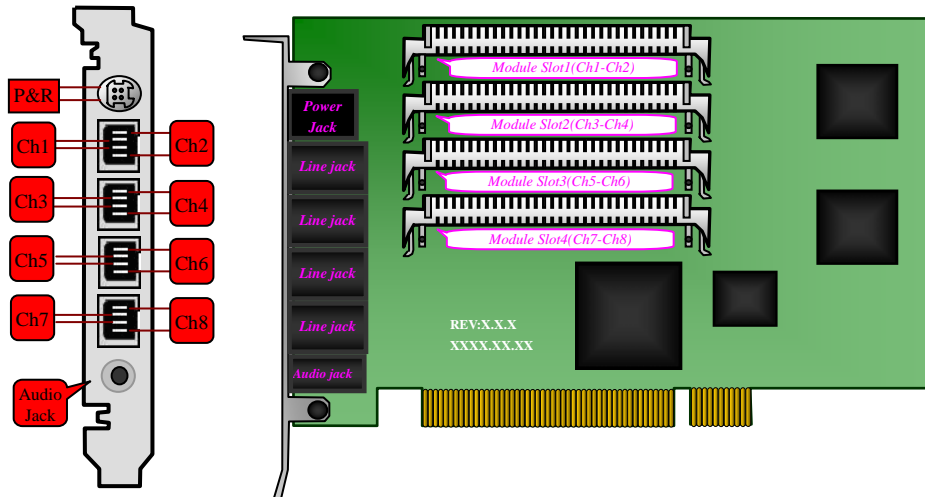

P&R: An interface for ringing current and battery feed power supply
 Ch1~Ch8: Interfaces to channels 1-8
 Audio Jack: Audio output interface, which is a $\phi 3.5$ stereo jack

Figure 2-1 Left and Front Views

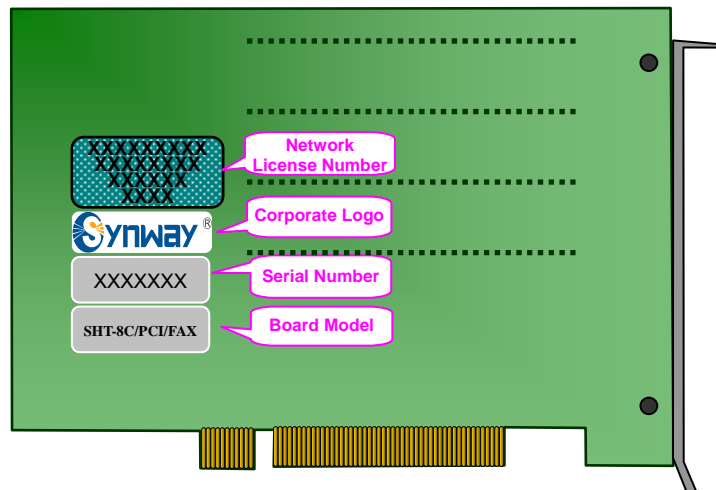

Figure 2-2 Rear View

- Analog Trunk Module

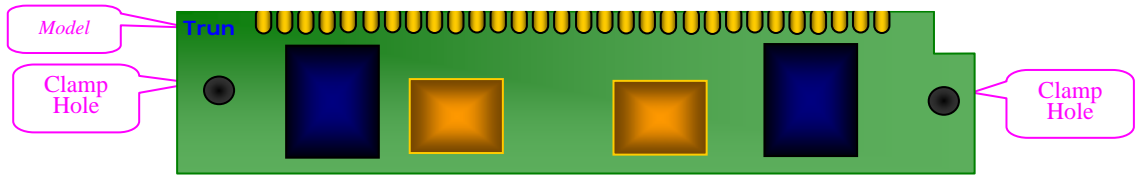

Figure 2-3 Front View

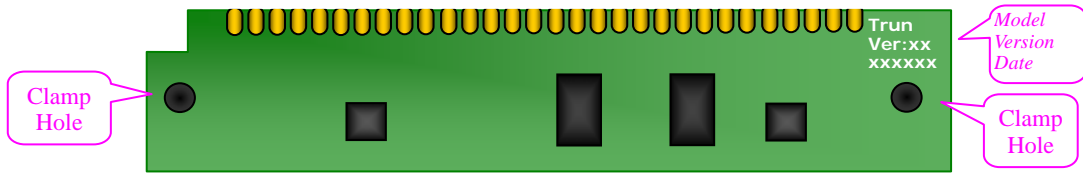

Figure 2-4 Rear View

● **Station Module**

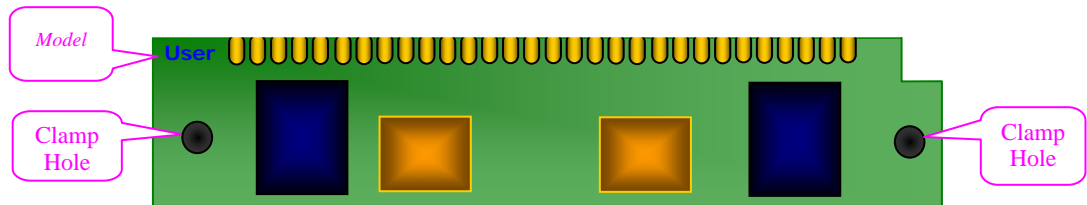

Figure 2-5 Front View

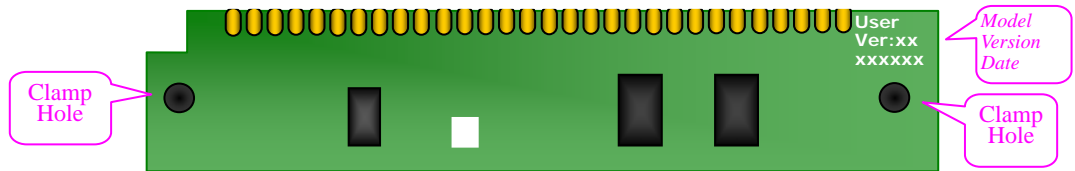

Figure 2-6 Rear View

● **Trunk-Station Composite Module**

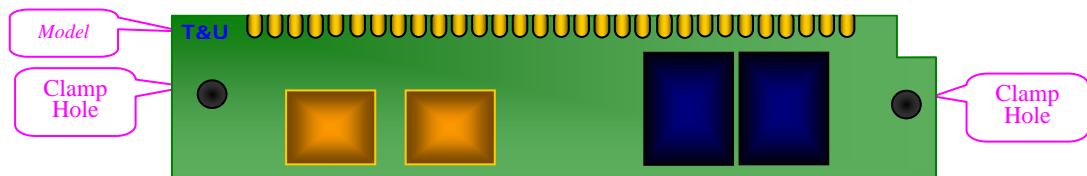

Figure 2-7 Front View

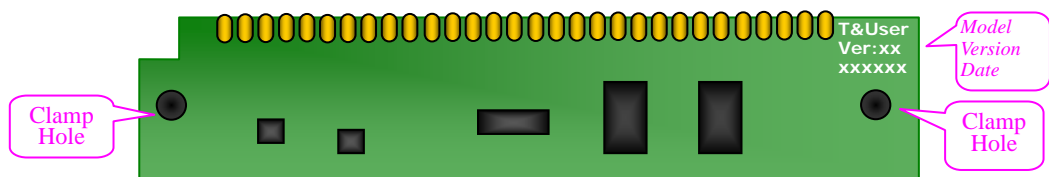

Figure 2-8 Rear View

- **Trunk-Record Composite Module**

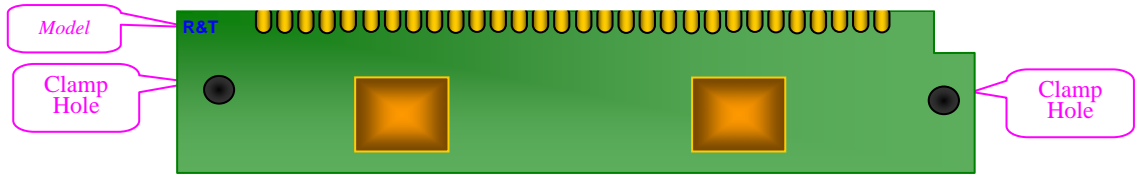

Figure 2-9 Front View

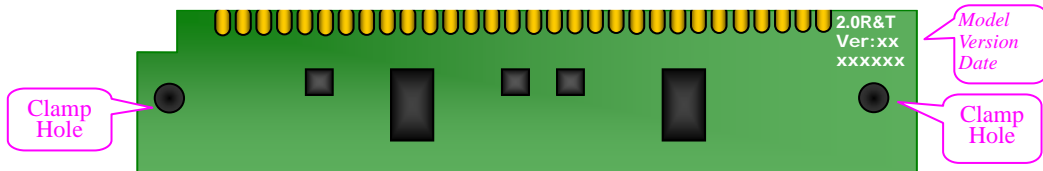

Figure 2-10 Rear View

- **Magnet Module**

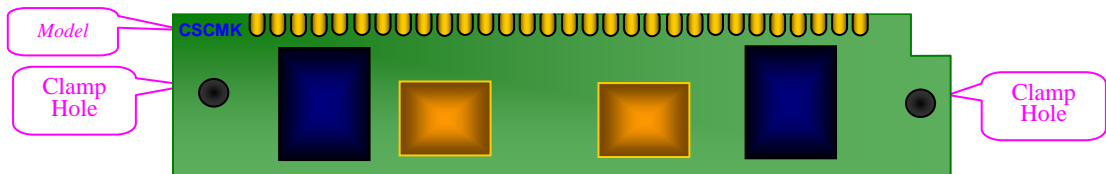

Figure 2-11 Front View

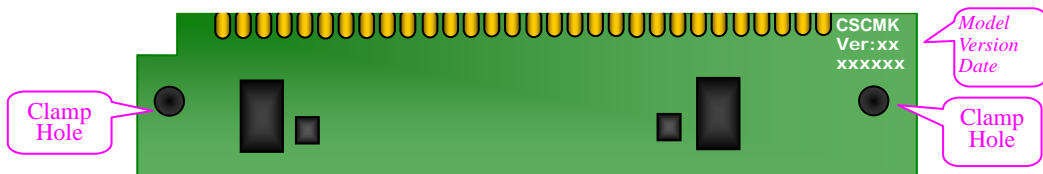

Figure 2-12 Rear View

- **EM2V100 Module**

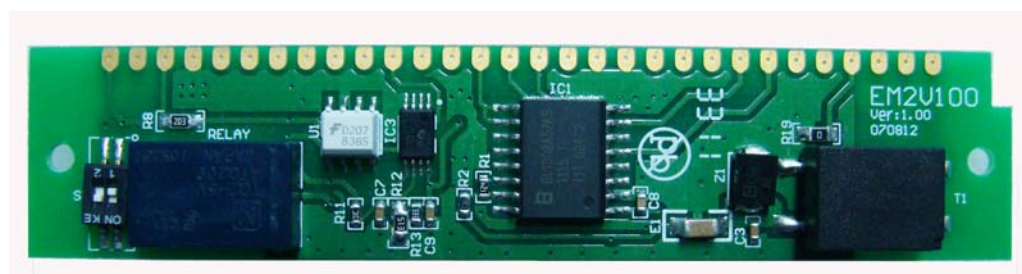

Figure 2-13 Front View



Figure 2-14 Rear View

2.2 System Requirements

Host System Requirements

CPU: 300MHz Intel® Pentium® II or above

Memory: 256M or more

HD: Depends on individual requirements

Supported Operating Systems

Refer to *SynCTI Programmer's Manual.pdf*.

2.3 Installation Procedure

Note: Always turn off the power before installation!

Step 1: Plug the desired modules into the module slots on the board, and fit the board into the PC chassis.

Step 2: Connect to analog phone lines or telephones.

A single board has four RJ11 jacks, each of which can be connected to a 4-lead line that corresponds to two channels. That is, the middle two pins of RJ11 link to a channel, and the outer two pins link to another. The pin layout and the corresponding channel numbers are shown in Figure 2-1.

Note: You can use a 2-way hub for conversion or construct lines by yourself following Figure 2-1 to complete the connection to the on-board RJ11 jacks.

Step 3: Connect to the EM2V100 module.

Skip this step if EM2V100 modules are not used.

To use the EM2V100 modules, there are two situations as shown below.

1) Used as an EM trunk channel carrying 2-line voice data

In such situation as a single EM2V100 module is used as an EM trunk channel carrying 2-line voice data, follow the figure '[Connect to EM Interface Carrying 2-line Voice Data](#)' to connect lines. To be exact, connect E at the local end to M at the remote end, M at the local

end to E at the remote end, and connect TIP and RING at the local end correspondingly to TIP and RING at the remote end.

Case: Use SHT-8B/PCI which includes RJ11 jacks as the motherboard to set up an EM trunk channel carrying 2-line voice data. See below for connection (refer to the pin definition of a single RJ11 jack).

1. E0	-----→	2. M0
2. M0	-----→	1. M0
3. Vp0	-----→	3. Vp0
4. Vn0	-----→	4. Vn0
Local		Remote

2) Used as an EM trunk channel carrying 4-line voice data

In such situation as two EM2V100 modules are combined to work as an EM trunk channel carrying 4-line voice data, follow the figure '[Connect to EM interface Carrying 4-line Voice Data](#)' to connect lines. There should be two pairs of voice lines for voice transmission, and a pair of E&M lines for EM control.

Case: Use SHT-16B-CT/PCI which includes RJ45 jacks as the motherboard to set up an EM trunk channel carrying 4-line voice data. See below for connection (refer to the pin definition of a single RJ45 jack).

1. E0	-----→	2. M0
2. M0	-----→	1. M0
3. Vp0	-----→	3. Vp0
4. Vn0	-----→	4. Vn0
5. E0	-----X-----→	5. E0
6. M0	-----X-----→	6. M0
7. Vp0	-----→	7. Vp0
8. Vn0	-----→	8. Vn0
Local		Remote

Note: In case two EM2V100 modules are combined to work as an EM trunk channel carrying 4-line voice data, only one pair of E&M lines need to be used. Therefore, the pair of E&M lines on the first module should be connected to the remote end, while that pair on the second module is suggested not to be connected.

Step 4: Connect to the ringing current & battery feed power supply

Skip this step if no station modules, trunk-station composite modules or EM2V100 modules are used.

If you are using the external ringing current & battery feed power supply from Synway, note that the plug has a peculiar design for the prevention of improper insertion and extraction. The correct way is to hold the plug body (not the locking ring, or it cannot be fully inserted) when inserting the plug home into the socket, and to grasp the locking ring (not the plug body or the conductor) when pulling the plug out from the socket. See Figure 2-15 below.

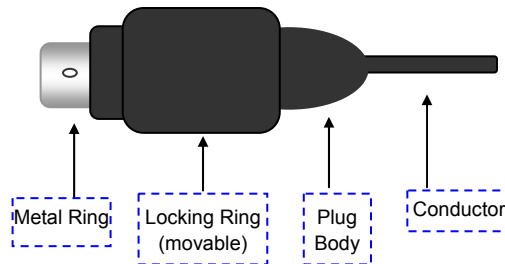

Figure 2-15 Plug Structure

Step 5: Connect to the trunk-station composite module

Skip this step if direct connection between internal and external lines is not required when the PC is powered off.

A trunk-station composite module accommodates a trunk channel and a station channel, and is seated in a dual-channel module slot. Before the board is powered on or the driver software is initialized, the station phone and the phone line which both share the same module are directly linked to allow emergency telecommunication. Once the board application program starts to run, the link automatically breaks and the internal and external lines become independent.

Note: When trunk-station composite modules are used, the adjacent two channels are by default a station channel and an analog trunk channel. Users can set whichever channel to be a station channel or an analog trunk one by modifying the configuration file.

Step 6: Connect the sound box or other proper sound devices

Skip this step if there is no need to 'monitor in real time' or 'play'.

Regarding how to choose proper sound devices, refer to 'Input/output Interface' and 'Audio Specifications' in *Appendix A Technical Specifications*

Note: The first module slot on the board must be fitted with a module should you wish to play sound via the amplifier.

Step 7: Boot your computer and install the driver

Regarding driver installation, refer to *SynCti_InstManual.pdf*.

Key Tips:

- As the system is expected to run for long hours unattended, 'energy-saving' mode should be turned off for both the CPU and the HD in CMOS or WINDOWS operating system. This is to ensure full-speed operation of the computer, or it may lead to a drop in performance or unexpected errors after running for some time.
- A chassis installed with voice boards must be grounded for safety reasons, according to standard industry requirements. A simple way is earthing with the third pin on the plug. No or improper grounding may cause instability in operation as well as decrease in lightning resistance.

Appendix A Technical Specifications

Dimensions

170×108mm² (excluding L-bracket)

Weight

≈ 250g

Environment

Operating temperature: 0 °C—55 °C

Storage temperature: -20 °C—85 °C

Humidity: 8%—90% non-condensing

Storage humidity: 8%—90% non-condensing

Input/output Interface

Headset jack: One ϕ 3.5 stereo jack

Telephone line jack: Four 4-pin RJ11 jacks

Audio Specifications

CODEC: CCITT A/ μ -Law 64kbps,

IMA ADPCM 32kbps

Output power: \geq 50mW

Distortion: \leq 3%

Frequency response: 300-3400Hz (\pm 3dB)

Signal-to-noise ratio: \geq 38dB

Echo suppression: \geq 40dB

Maximum System Capacity

Up to 10 analog fax boards concurrently per system; up to 8 channels per board

Power Requirements

+5V DC: 600mA

-12V DC: 80mA

+12V DC: 300mA

Maximum power consumption: \leq 12W
(PC power only)

Impedance

Input impedance: \geq 1M Ω /500V DC;

\geq 10k Ω /1000V AC

Insulation resistance for PC isolation from telephone line: \geq 2M Ω /500V DC

Telephone line impedance:

Compliant with the national standard

impedance for three-component network

Audio Encoding & Decoding

16Bit PCM 128kbps

8Bit PCM 64kbps

A-Law 64kbps

μ -Law 64kbps

VOX 32kbps

ADPCM 32kbps

GSM 13.6kbps

MP3 8kbps

Sampling Rate

8kHz

Safety

Lightning resistance: Level 4

Appendix B Technical/sales Support

Thank you for choosing Synway. Please contact us should you have any inquiry regarding our products. We shall do our best to help you.

Headquarters

Synway Information Engineering Co., Ltd

<http://www.synway.net/>

9F, Synway D&R Center, No.3756, Nanhuan Road, Binjiang District, Hangzhou, P.R.China, 310053

Tel: +86-571-88860561

Fax: +86-571-88850923

Technical Support

Tel: +86-571-88864579

Mobile: +86-18905817070

Email: techsupport@sanhuid.com

Email: techsupport@synway.net

MSN: synway.support@hotmail.com

Sales Department

Tel: +86-571-88860561

Tel: +86-571-88864579

Fax: +86-571-88850923

Email: sales@synway.net